

Model IG-4 Hang

Installation and Maintenance Instructions

For ALL installations:

- Display or sign load MUST be balanced.
 - Do NOT exceed rated capacity of unit.
-

Display or Sign hanging from Rotator:

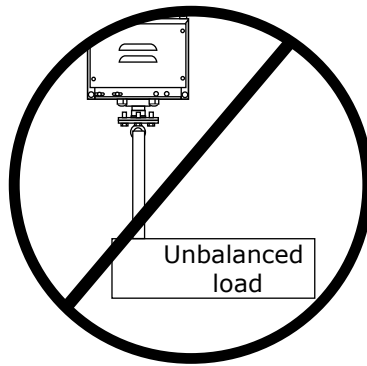
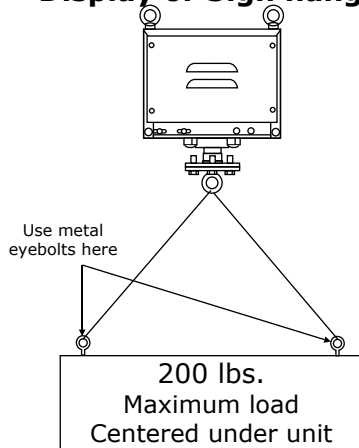



- Max hanging weight = 200 lbs
 - Eyebolts can be added for rigging.
 - Hanging load MUST be balanced and centered under unit.
 - Use wire rope to allow hanging sign to self-balance.
 - Do NOT exceed weight rating of rotator.
 - Do NOT allow bare wire rope to rub on eyebolt.
 - Wire rope should be protected to prevent fraying or failure.
-

Maintenance:

No regular maintenance is required for this unit.

Model IG-4 Hang

Electrical Connections

 WARNING	
	Disconnect power before servicing or installing. Do not touch any electrical components while unit is connected to power source.
	Keep hands clear while operating. Read installation and maintenance instructions prior to operation.

Unit with rotating wires/outlet:

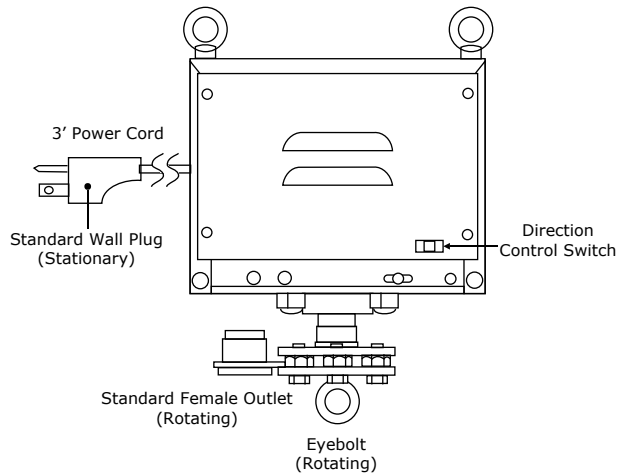

- **WARNING!** Electrical components are live when unit is plugged in.
- Do NOT exceed rated electrical capacity of unit (see label on unit).
- Plug sign wiring into outlet on turntable.
- Plug unit into wall.
- Press direction switch to start unit.
- Motor power draw = 0.1 A (12 watts)

Unit without rotating wires/outlet:

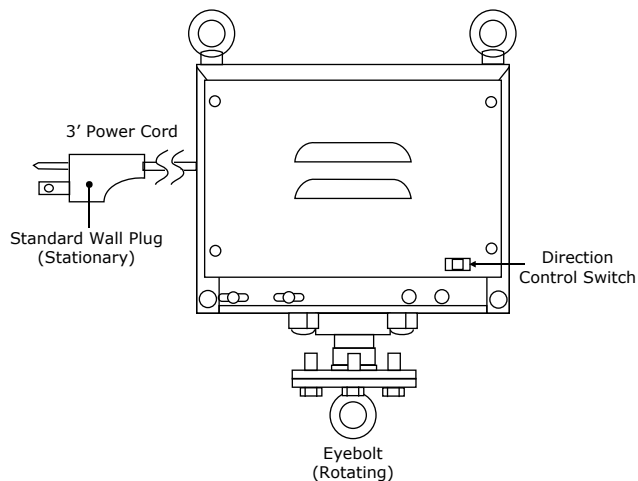

- No rotating electrical wires are available.
- Plug unit into wall.
- Press direction switch to start unit.
- Motor power draw = 0.1 A (12 watts)