

VECTOR FRAME BANNERS S-03

SET-UP NOTES

1. Redesign of this exhibit without approval by the manufacture may result in dangerous and unsafe structures. The manufacture disclaims any responsibility for redesigned exhibits it does not approve in writing.
2. Parts and components such as panels and extrusions are manufactured to metric sizing. Where ever possible sizes have been noted in feet and inches as well as in metric. Below is the imperial to metric sizing table as reference. "Nominal" refers to approximate size.

IMPERIAL TO METRIC SIZES

8' Nominal = 94 1/2" or 2400mm Actual
4' Nominal = 47 1/4" or 1200mm Actual
3' Nominal = 35 7/16" or 900mm Actual
2' Nominal = 23 5/8" or 600mm Actual
1' Nominal = 11 13/16" or 300mm Actual

VECTOR FRAME BANNERS S-03

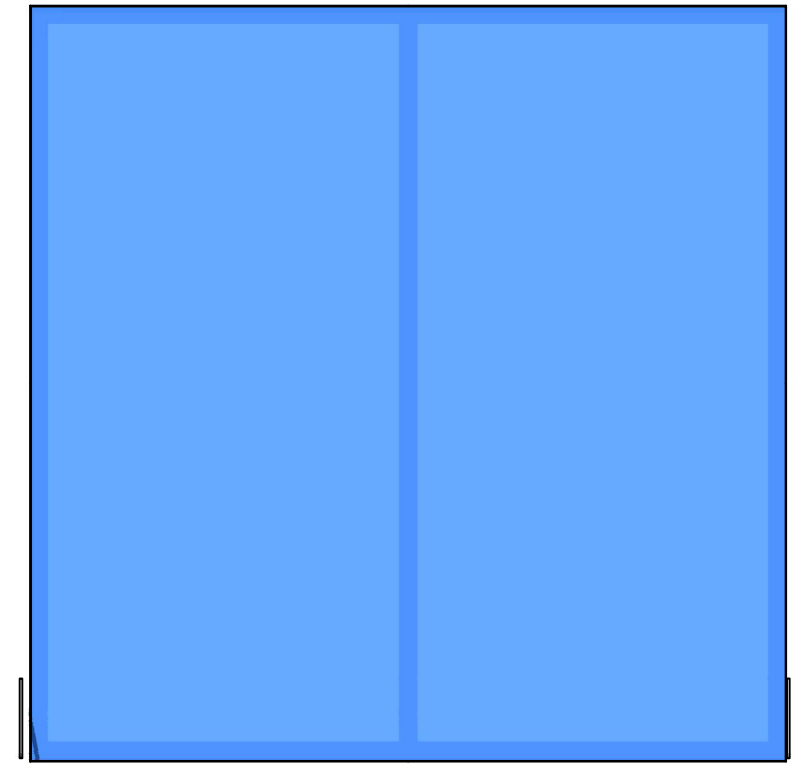
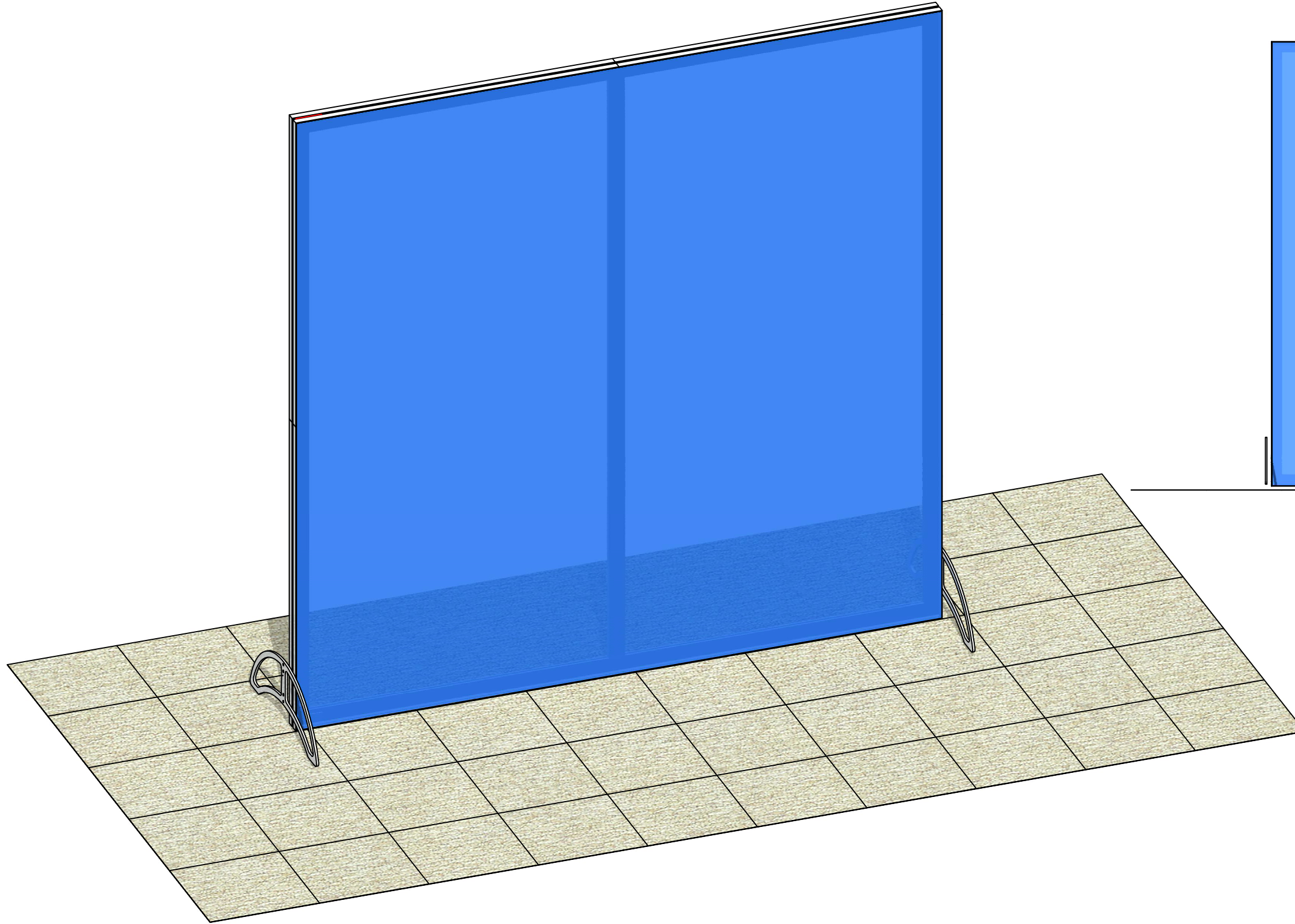

Code	#	Description
SL2-500	2	Support Leg
F13	8	PHFC2-900-3[35 3/8"] (Mitre / Corner Lock one end - straight cut & lock hole other end - NO Locks
IB2	5	END TO END LOCK CONNECTOR
CB9	4	90 DEGREE CORNER LOCK CONNECTOR
F3	2	855MM[36 3/8"]PH EXTRUSION W/1 LOCK

NOTE: TURN EACH CAM A LITTLE BIT, AND THEN GO BACK AND TIGHTEN BOTH TO THE PROPER TENSION.

NOTE: TURN EACH CAM A LITTLE BIT, AND THEN GO BACK AND TIGHTEN BOTH TO THE PROPER TENSION.

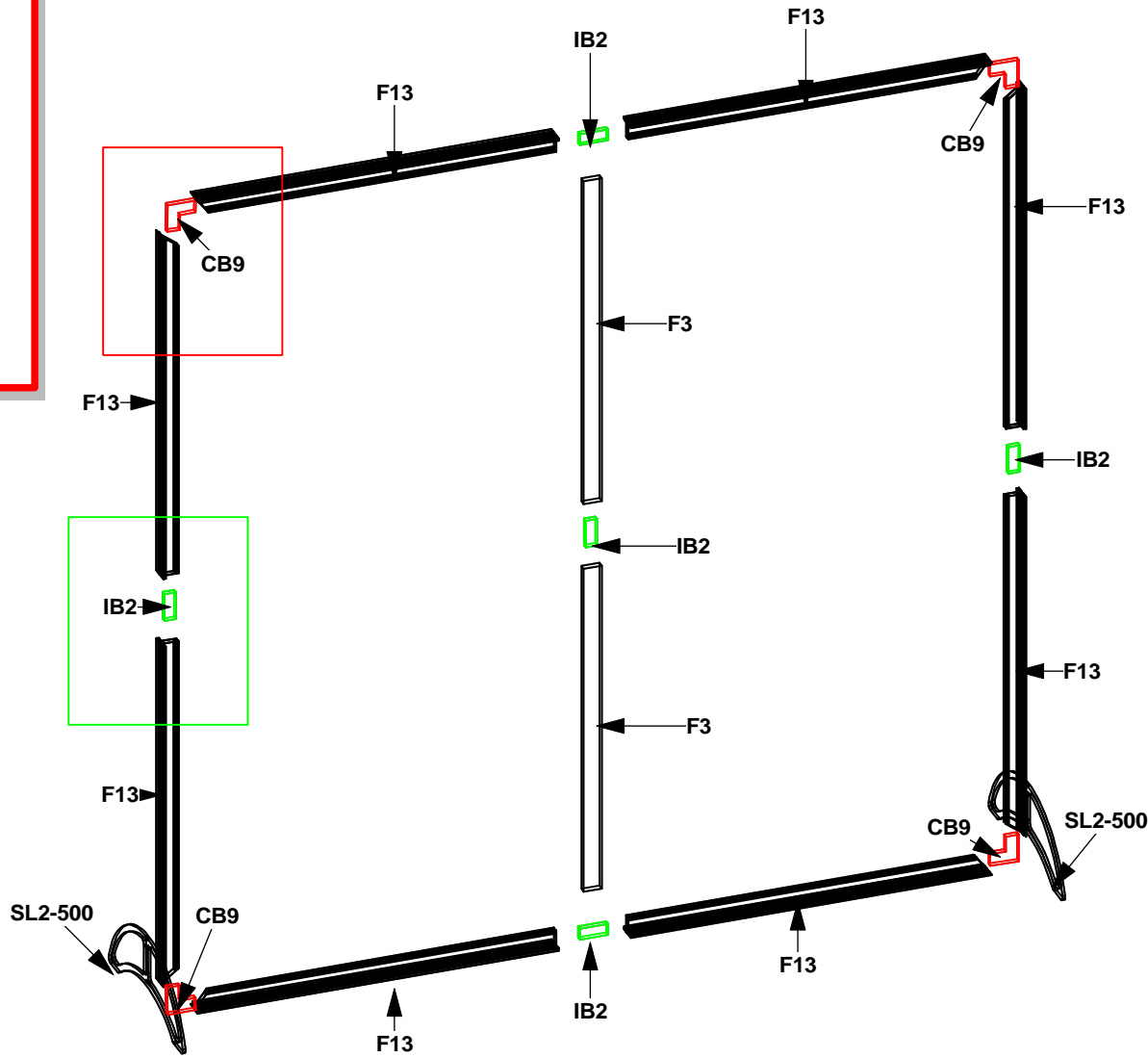
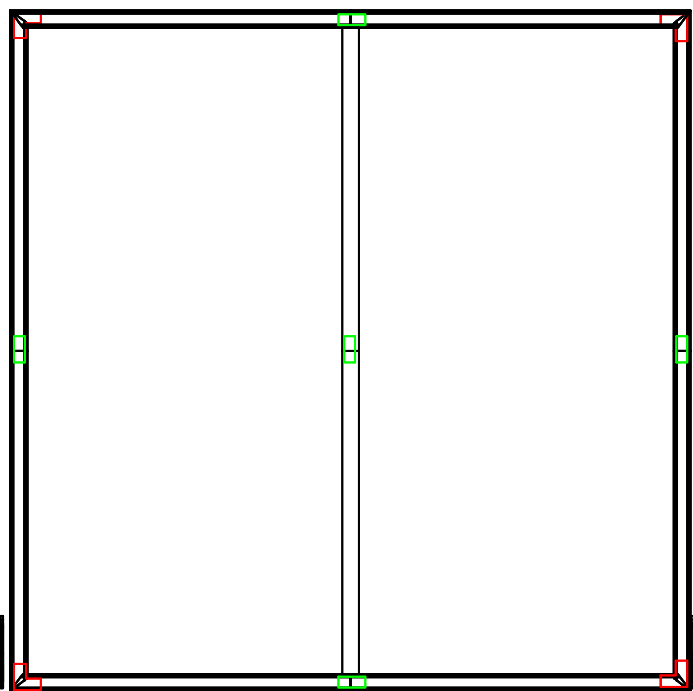

IB2 TO PHFC2

Slide IB2 together with extrusion. Then tighten the screws to lock the IB2s together

SL2-500 TO PHFC2

LOCK HORIZONTAL EXTRUSION BY USING T-HANDLE TOOL

90 Deg. CB9 TO PHFC2

Slide CB9 together with extrusion. Then tighten the screws to lock the CB9s together

1. Redesign of this exhibit without approval by the manufacture may result in dangerous and unsafe structures. The manufacture disclaims any responsibility for redesigned exhibits it does not approve in writing.
 2. Parts and components such as panels and extrusions are manufactured to metric sizing. Where ever possible sizes have been noted in feet and inches as well as in metric. Below is the imperial to metric sizing table as reference. "Nominal" refers to approximate size.

2400mm = (94 1/2")	Phone Line / Fax
2100mm = (82 5/8")	Internet connection
1800mm = (70 7/8")	Outlet
1500mm = (59")	Main Drop (point of distrution)
1200mm = (47 1/4")	
900mm = (35 1/2")	
600mm = (23 5/8")	
300mm = (11 7/8")	

--- Wire running under carpet

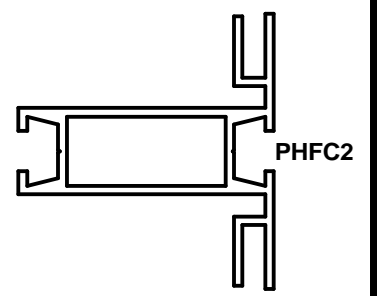

VECTOR FRAME BANNERS S-03

Title: SET-UP INSTRUCTIONS

Code	#	Description
SMP-64-G	1	70.87"H X 70.87"W SINGLE SIDED DYESUB GRAPHIC (UNLINED) PRINTED ON OXFORD W/ FCE-2 ALL 4 SIDES

1. Redesign of this exhibit without approval by the manufacture may result in dangerous and unsafe structures. The manufacture disclaims any responsibility for redesigned exhibits it does not approve in writing.
 2. Parts and components such as panels and extrusions are manufactured to metric sizing. Where ever possible sizes have been noted in feet and inches as well as in metric. Below is the imperial to metric sizing table as reference. "Nominal" refers to approximate size.

2400mm = (94 1/2")	Phone Line / Fax
2100mm = (82 5/8")	Internet connection
1800mm = (70 7/8")	Outlet
1500mm = (59")	Main Drop (point of distrution)
1200mm = (47 1/4")	
900mm = (35 1/2")	
600mm = (23 5/8")	
300mm = (11 7/8")	

--- Wire running under carpet

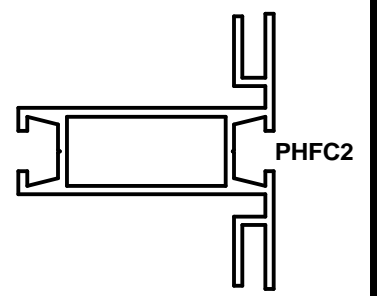
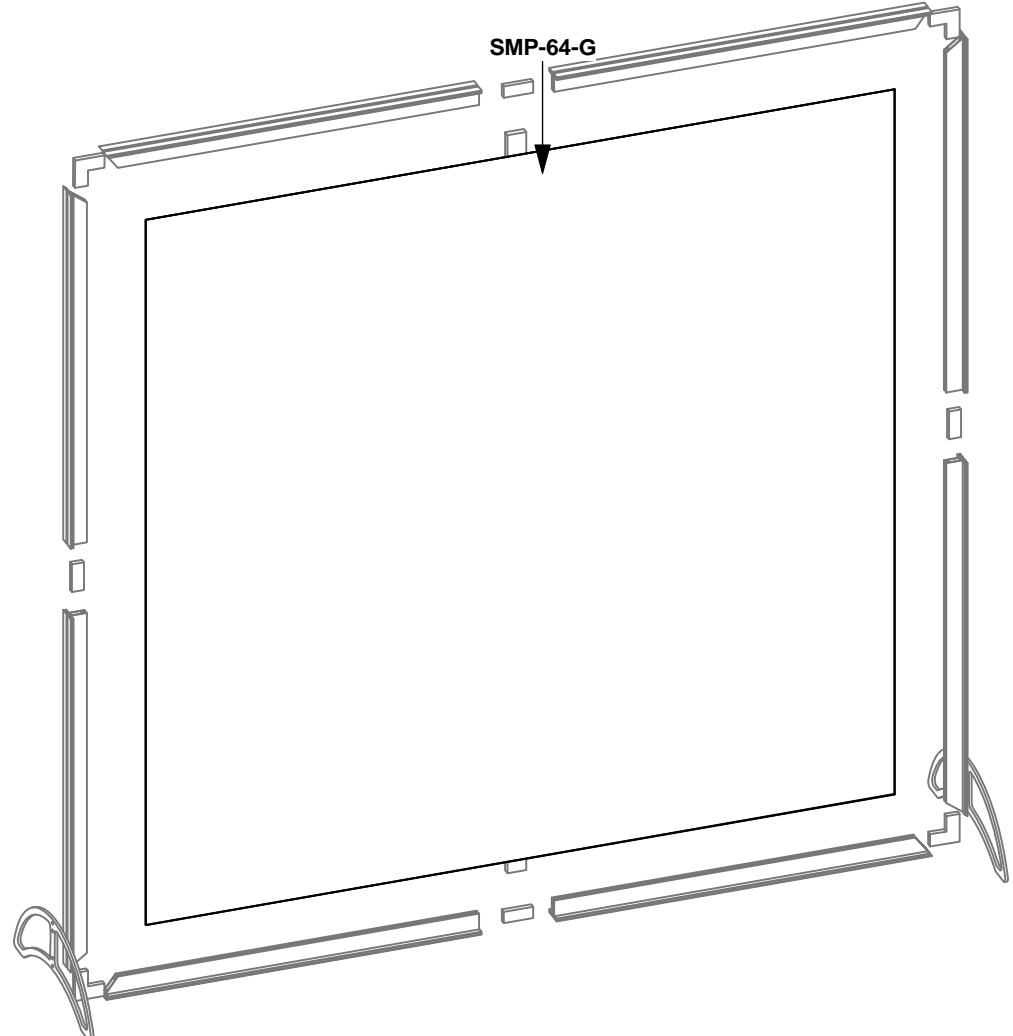
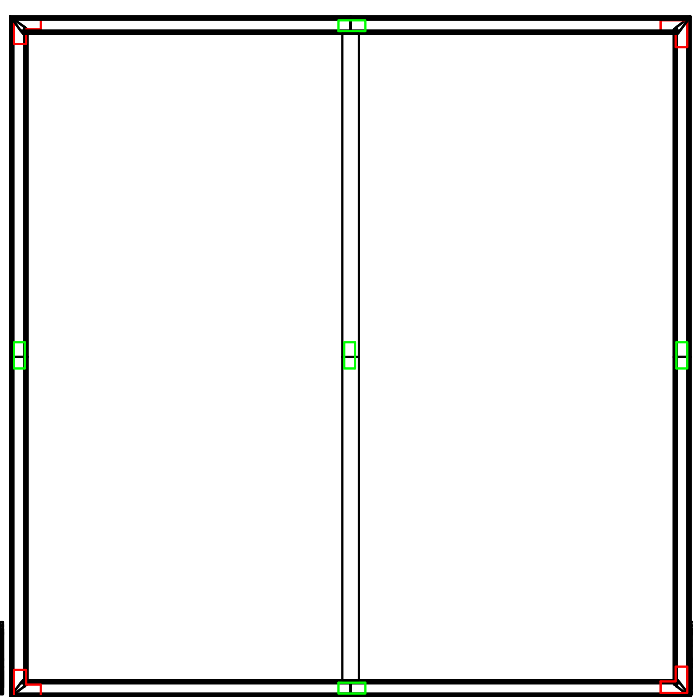
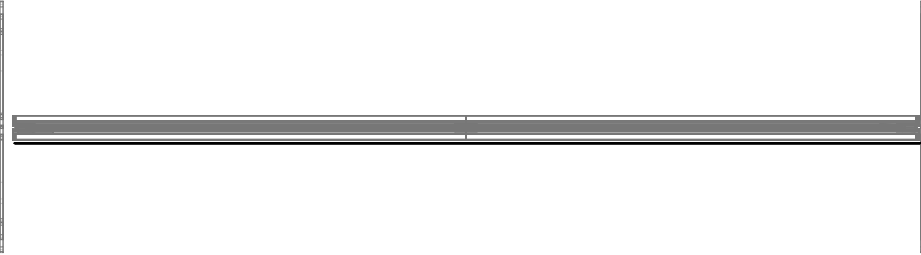

GRAPHIC WITH FCE-2 TO PHFC2

Install graphic by pressing the FCE-2 into the top and bottom channels of PHFC2 extrusion. To pull graphics out of the channels use tabs on the front side

VECTOR FRAME BANNERS S-03
 Title: SET-UP INSTRUCTIONS