



**WS** WholeSale Displays  
**DISPLAY**.com

**PRODUCT TRAINING**



## SEGO + QSEG



When modular worlds collide! The SEGO + QSEG configurations offer a perfect blend of backlit and non-backlit graphics for your trade show or exhibition needs. Emphasize your message with vibrant backlit graphics on SEGO lightbox frames that pair well with non backlit graphics on the QSEGs. All frames showcase double sided graphics so your message can be seen from almost any angle. All graphics are dye sub printed with SEG (Silicone Edge Graphic) finishing which makes for easy graphic install and change out. Frame assembly and modular connection is all tool free so you don't have to worry about having tools on hand for booth setup and breakdown. Specialized connectors were developed to marry the two systems and have connectors for inline as well as 90o corners. Choose from our standard SEGO + QSEG configurations or contact us for a custom quote. SEGO + QSEG.... Name a better duo I'll wait...

# OVERVIEW



- Pre Designed booth configurations utilizing SEGO and QSEG frames
- Standard configurations are designed for 20' x 10' and 20' x 20' tradeshow booth spaces.
  - \*Please check your tradeshow guidelines to make sure the configuration conforms to the show regulations. If adjustments to the configuration are required to meet the show requirements please contact us for a custom configuration quote\*
- Special connectors allow SEGO and QSEG frames to be connected inline (side by side) and also at 90° angles
- Connectors can be purchased a la carte
- Custom configurations are available upon request

# CONFIGURATION A

- **SKUs**

- SEGO-QSEG-A-G (graphic package)
- SEGO-QSEG-A-GO (graphic only)
- SEGO-QSEG-A-HO (hardware only)



Graphic Package

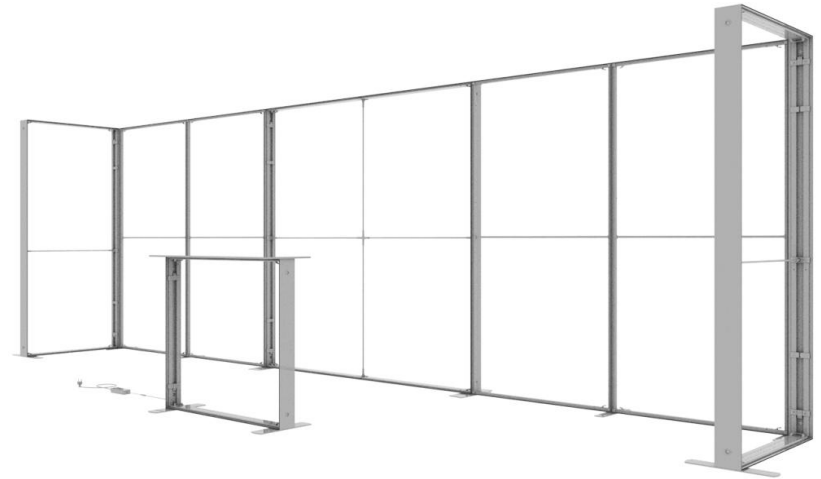

Hardware Only

# CONFIGURATION A

## Hardware Only Parts List



(qty 4)  
QSEG-100X225

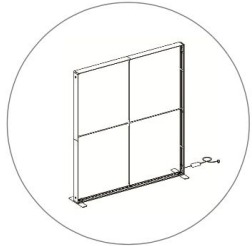

(qty 1)  
SEGO-200X225X12

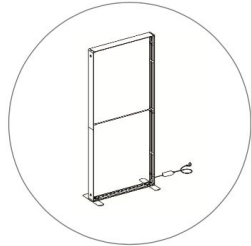

(qty 2)  
SEGO-100X225X12

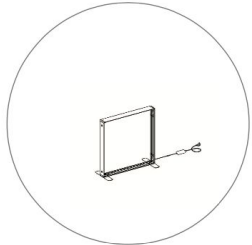

(qty 1)  
SEGO-CNTR

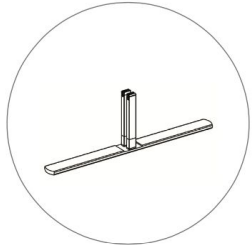

(qty 1)  
QSEG-TPFF

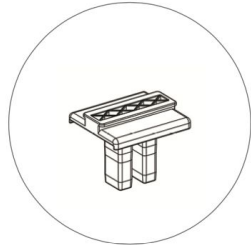

(qty 2)  
QSEG-SCON

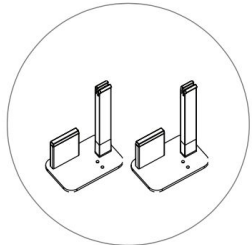

(qty 1 sets)  
SEGO-QSEG-SB-CON

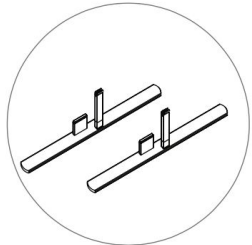

(qty 1 sets)  
SEGO-QSEG-ST-CON

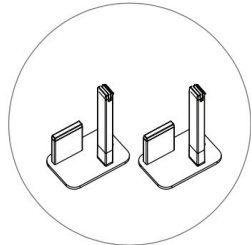

(qty 2 sets)  
SEGO-QSEG-LTBASE-CON

# CONFIGURATION B

- **SKUs**

- SEGO-QSEG-B-G (graphic package)
- SEGO-QSEG-B-GO (graphic only)
- SEGO-QSEG-B-HO (hardware only)



Graphic Package

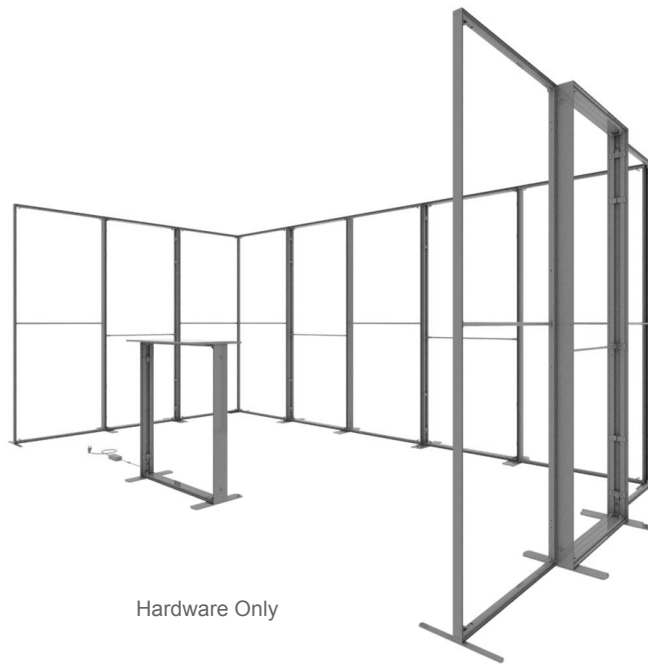

Hardware Only

# CONFIGURATION B

## Hardware Only Parts List



(qty 7)  
QSEG-100x225

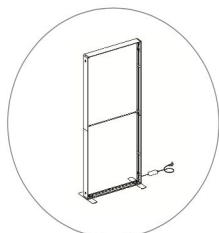

(qty 4)  
SEGO-100X225X12

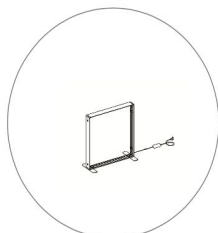

(qty 1)  
SEGO-CNTR

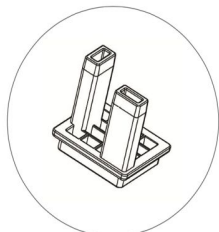

(qty 2) (pair)  
QSEG-LCON

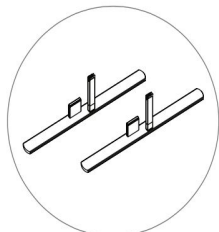

(qty 8 sets)  
SEGO-QSEG-ST-CON

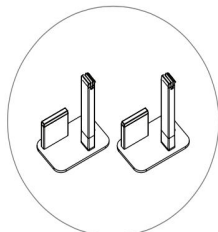

(qty 2 sets)  
SEGO-QSEG-LTBASE-CON

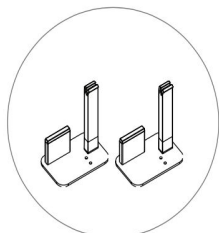

(qty 8 sets)  
SEGO-QSEG-SB-CON

# CONFIGURATION C

- **SKUs**

- SEGO-QSEG-C-G (graphic package)
- SEGO-QSEG-C-GO (graphic only)
- SEGO-QSEG-C-HO (hardware only)



Graphic Package

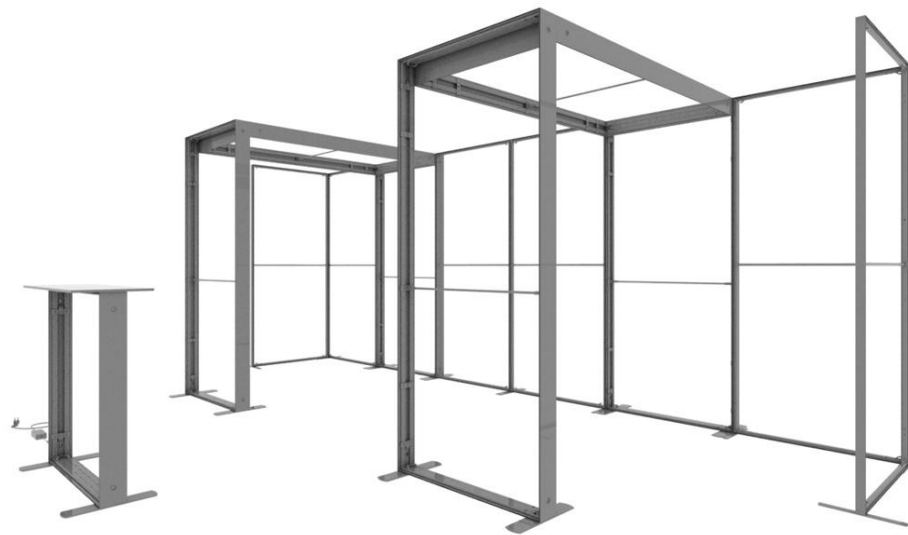

Hardware Only



# CONFIGURATION C

## Hardware Only Parts List



(qty 6)  
QSEG-100x225

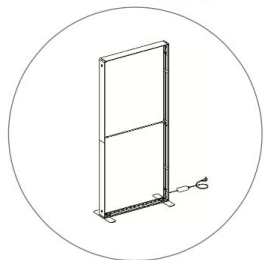

(qty 6)  
SEGO-100X225X12

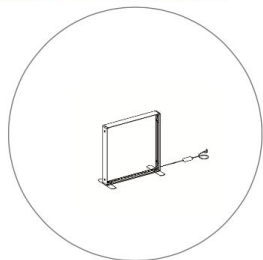

(qty 1)  
SEGO-CNTR

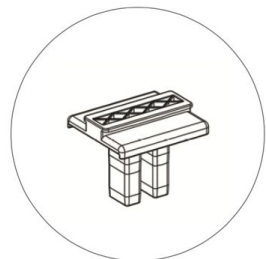

(qty 1)  
QSEG-SCON

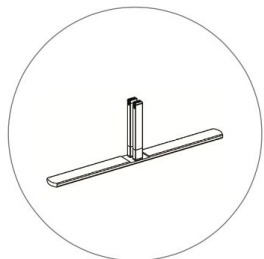

(qty 1)  
QSEG-TPFF

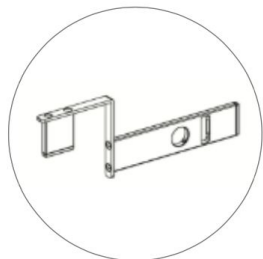

(qty 8)  
SEGO-BC

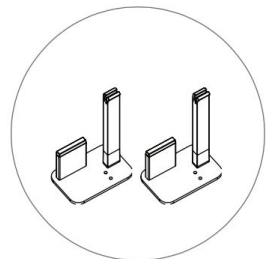

(qty 4 sets)  
SEGO-QSEG-SB-CON

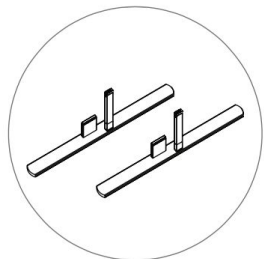

(qty 8 sets)  
SEGO-QSEG-ST-CON



(qty 2)  
SEGO-5MWIRE

# CONNECTORS

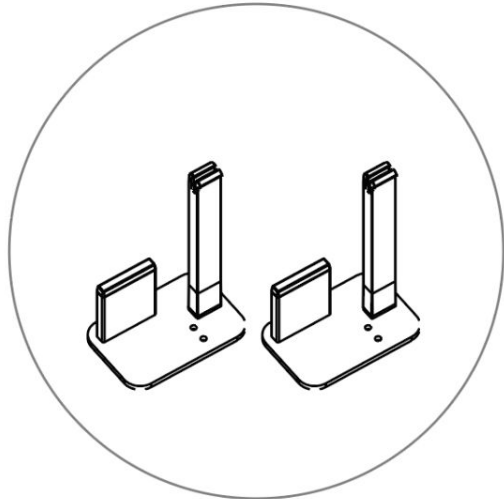

(qty 1 = 1 set)  
SEGO-QSEG-SB-CON

Straight Top Connector Set  
Includes Left & Right Sides

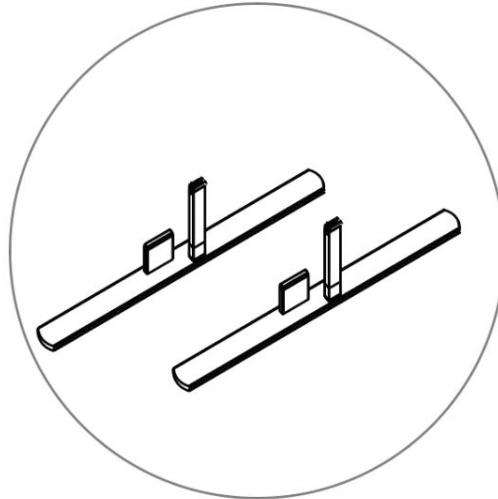

(qty 1 = 1 set)  
SEGO-QSEG-ST-CON

Straight Bottom Connector Set  
Includes Left & Right Sides

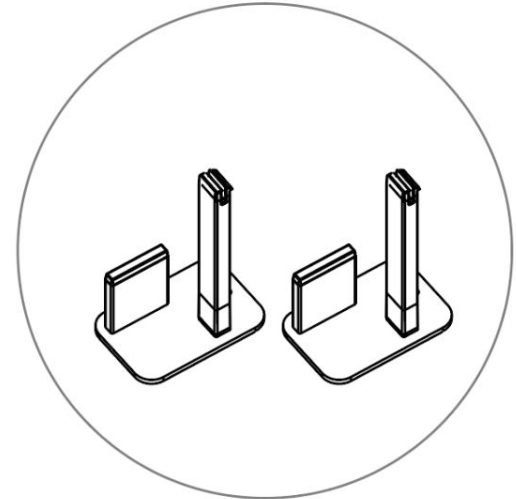

(qty 1 = 1 set)  
SEGO-QSEG-LTBASE-CON

90° Connector Set  
Includes Top & Bottom

# TEMPLATES

Each configuration has a template guide to reference. The guide indicates which template corresponds to which frame and also how to also name your files for proofing and production.

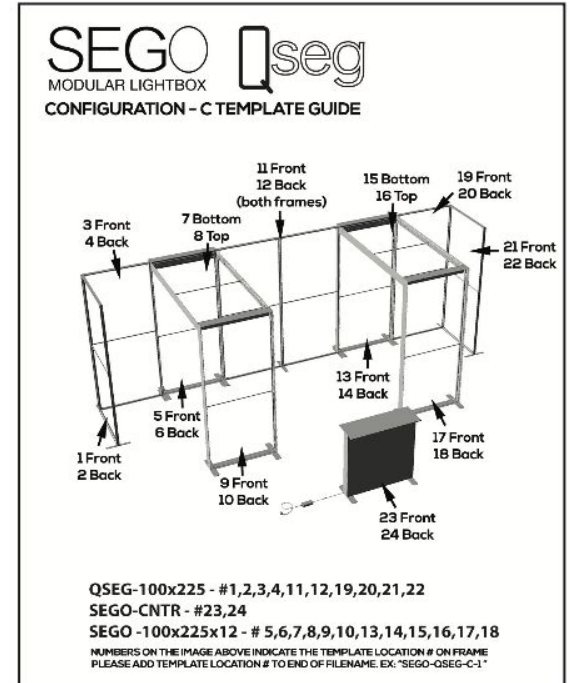
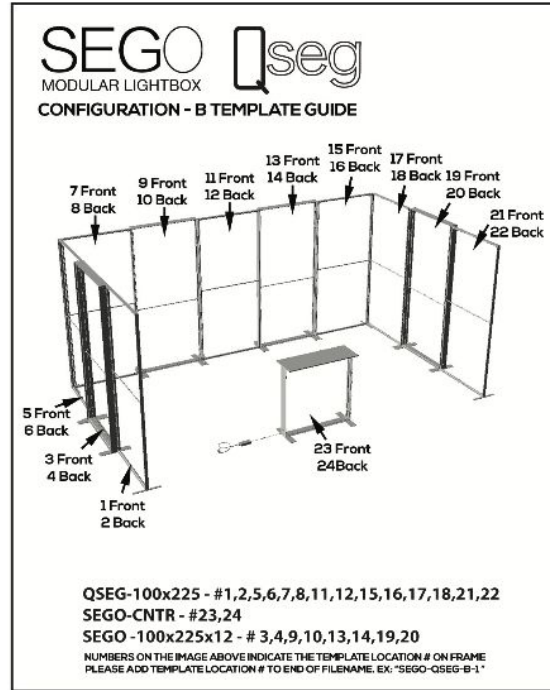
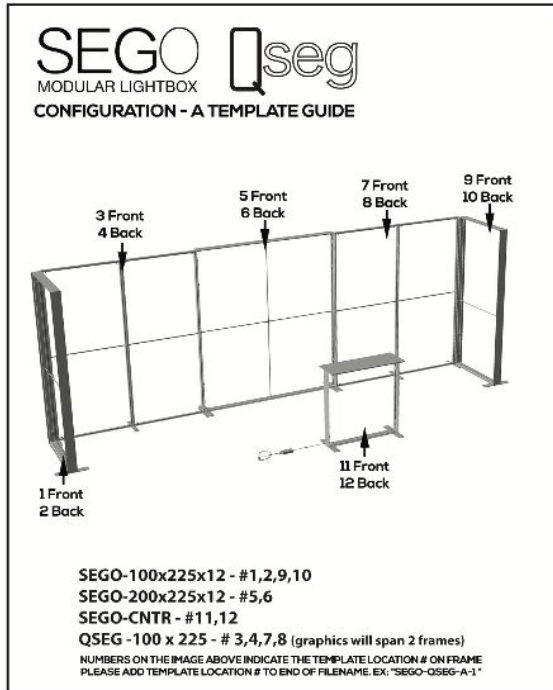

# GRAPHIC INFO



## Stretch - OC

Thickness	Printing Process	Finishing	Maximum Media Width
8.08 oz	Dye Sublimation Paper Transfer	Soft Look Bright Colors	94"

QSEG Graphics



## Dye Sub Backlit - OC

Thickness	Printing Process	Finishing	Maximum Media Width
5.25 oz	Dye Sublimation Paper Transfer	Soft Look Bright Colors	117"

SEGO Graphics

- **Material:**
  - **Dye Sub Backlit (INV-FAB-BL):** for SEGO
  - **Stretch Fabric (INV-FAB-STRETCH) :** for QSEG
- **Print Process:**
  - Paper transfer dye sublimation
- **Finishing:**
  - 12mm x 3mm keder sewn around perimeter of graphic
  - Pull tab added to bottom corner to help with graphic removal
- **Graphic Options:**
  - Graphic Package - Includes hardware and all graphics
  - Graphic Only - Full set of backlit and non-backlit graphic to reskin configuration
- **Production Time:** See product pages for current production times
- **Locations:** See product pages for location availability

# SHIPPING & WARRANTY



## Shipping

- Graphic Packages Ship from PFC
- Graphic Onlys Ship from PFC
- Hardware Only Ship from PFC

## Warranty

- 1 year warranty on graphics
- Lifetime warranty on hardware

## Returns

- RMA's will be shipped back to CA or PA

## Shipping Dimensions

- See Spec Sheets or Product Pages for Shipping Information