

CABO F

RESORT EXTRUSIONS

PRODUCT CODE: CABO-F



On frame On graphic

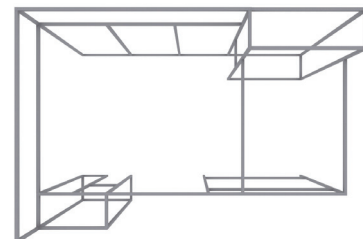
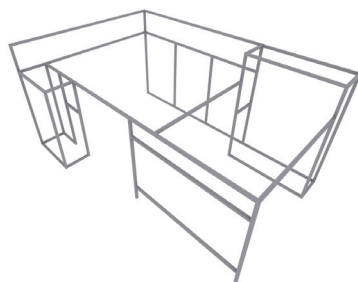
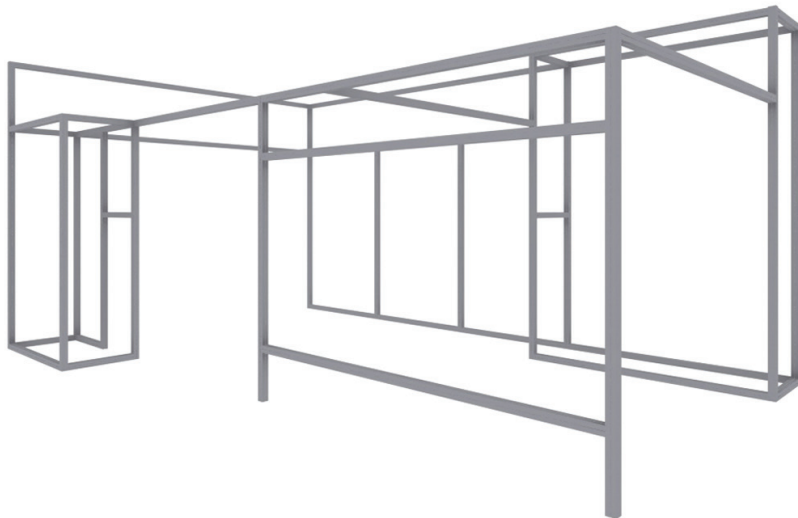

PRODUCT DESCRIPTION

The Cabo aluminum extrusion profile system is an elegant and versatile solution for all of your display needs. Featuring a sleek silver anodized finish, the Cabo is the perfect solution for tradeshow booths, retail environments, pop up shops, or any place aluminum framing is needed. The profiles are available in standard 40mm and 80mm profile widths and in different shapes allowing you to turn your display vision into reality. Promote your company, new products, etc with custom dye sublimated fabric graphics. 12mm x 3mm silicone beading (SEG) is sewn around the perimeter of each fabric panel for easy installation and removal of your graphics. Choose from one of our pre designed configurations or contact us for a quote on something totally custom.

DISPLAY DIMENSIONS	354"W x 172.2"H x 230.7"D
GRAPHIC SIZE	See Template Page

GRAPHIC MATERIAL

Dye-Sublimated Black and White Fabric. Fabric graphic material with an integrated blockout. Backside of the graphics are black.

GRAPHIC FINISHING

12mm x 3mm silicone beading is sewn around the perimeter of the fabric graphic. Silicone beading is hidden from view once installed.

DISPLAY CONSTRUCTION

Extruded aluminum profile frame with aluminum and steel components

SHIPPING WEIGHTS & DIMENSIONS

Shipping Weight (Includes Shipping Crate)	1440 lbs (frame only) - LTL ONLY 1490 lbs (frame & graphic) - LTL ONLY
Shipping Crate Dimensions	102"L x 49.5"W x 44.5"H

GRAPHIC TURN AROUND TIME

5 business days after proof approval

AVAILABILITY	PFC
--------------	-----

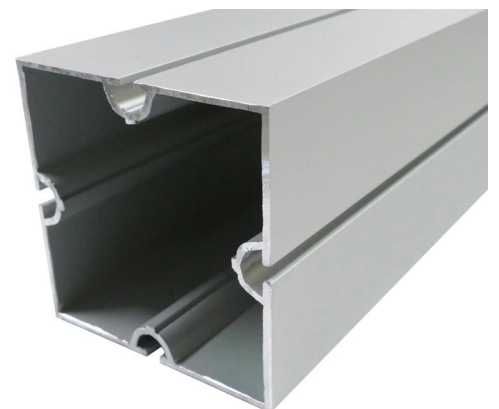

PARTS LIST HARDWARE ONLY

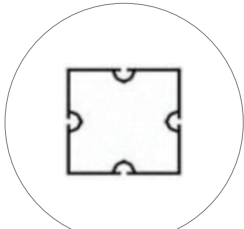

CABO-80 86.1" W
(qty 12)

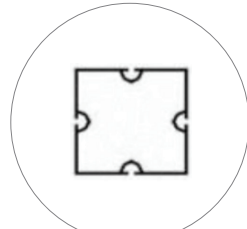

CABO-80 66.54" W
(qty 16)

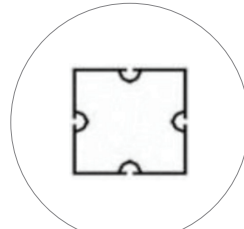

CABO-80 76.9" W
(qty 6)

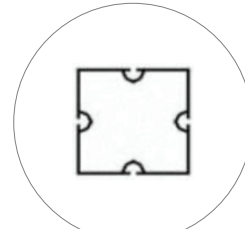

CABO-80 95.85" W
(qty 2)

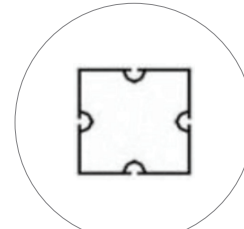

CABO-80 76.4" W
(qty 10)

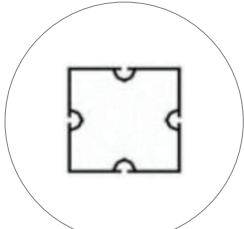

CABO-80 56.9" W
(qty 10)

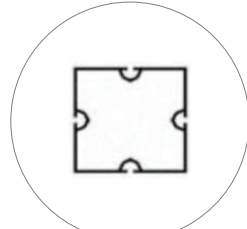

CABO-80 74.8" W
(qty 8)

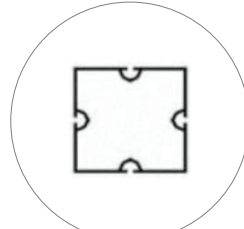

CABO-80 35.8" W
(qty 12)

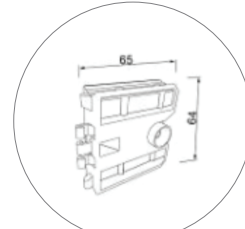

CABO-80-LOCK
(qty 68)

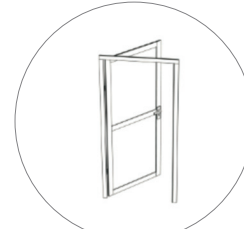

CABO-DOOR
(qty 2)

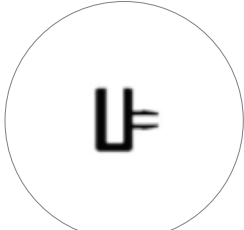

CABO-SEG-PLASTIC 35.7" W
(qty 14)



CABO-SEG-PLASTIC 48.1" W
(qty 2)



CABO-SEG-PLASTIC 74.7" W
(qty 8)

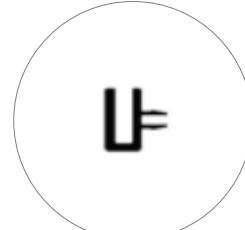

CABO-SEG-PLASTIC 87.1" W
(qty 2)

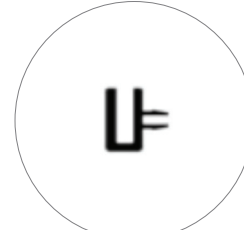

CABO-SEG-PLASTIC 56.85" W
(qty 8)



CABO-SEG-PLASTIC 63.45" W
(qty 28)



CABO-SEG-PLASTIC 82.95" W
(qty 12)



CABO-SEG-PLASTIC 76.9" W
(qty 6)

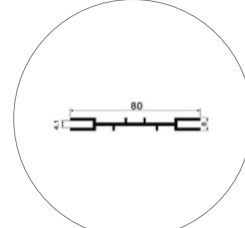

CABO-80-SEG 35.7" W
(qty 2)

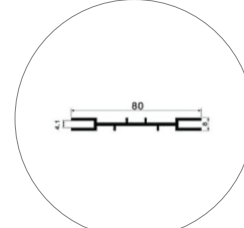

CABO-80-SEG 70.8" W
(qty 2)

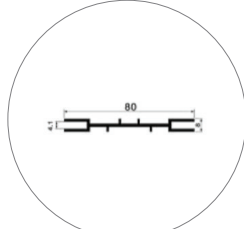

CABO-80-SEG 76.35" W
(qty 4)

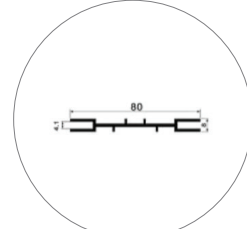

CABO-80-SEG 76.9" W
(qty 9)



CABO-HHS
(qty 61)

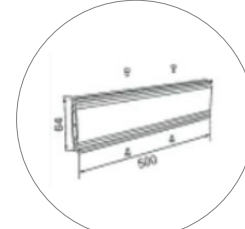

CABO-80-ADPT
(qty 28)



CABO-LTORX
(qty 1)



CABO-TSCREWDRIVER
(qty 1)

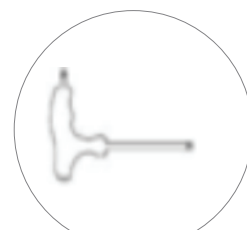

CABO-TTORX
(qty 1)

Template Guide

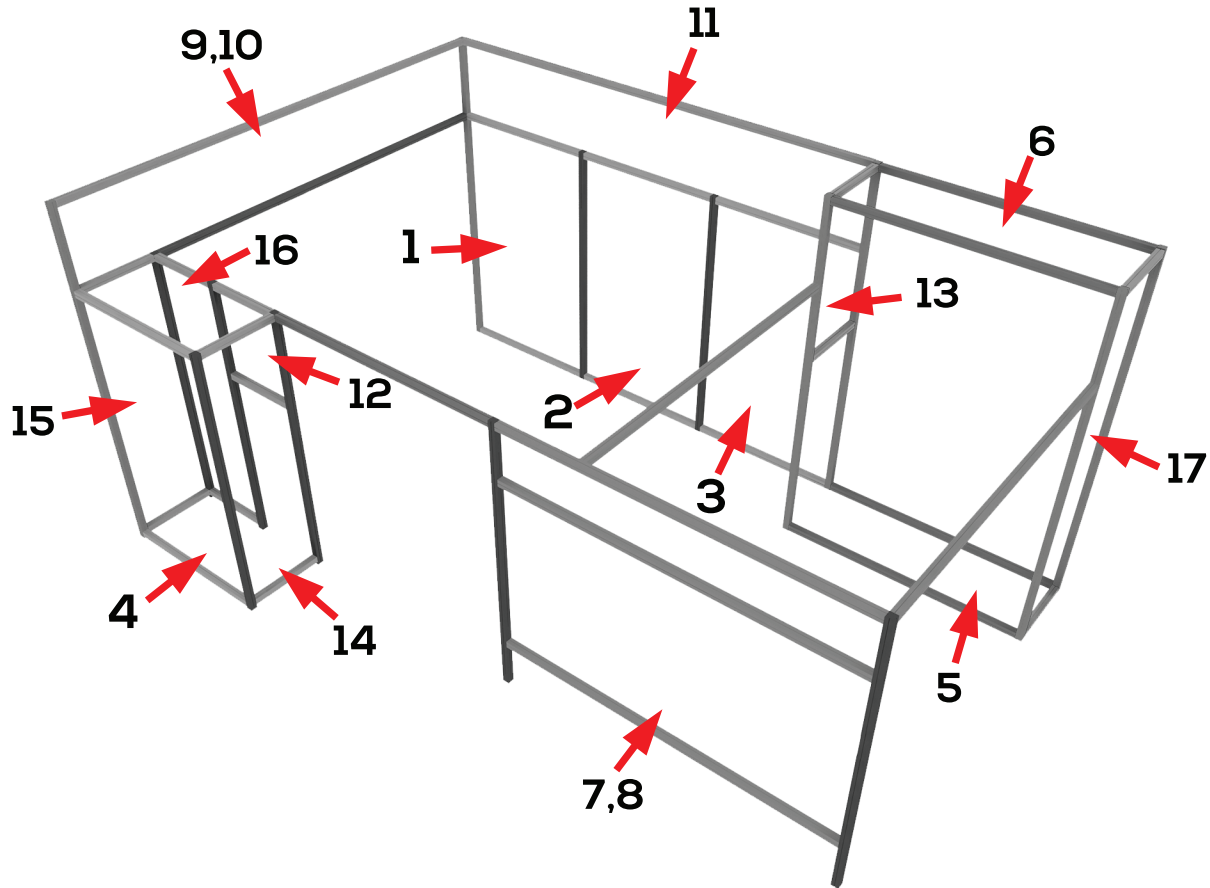

PANEL	DIMS	NOTES
1	74.8" W x 127" H	Inside Print
2	74.8" W x 127" H	Inside Print
3	74.8" W x 127" H	Inside Print
4	74.8" W x 127" H	Outside Print
5	113.8" W x 166" H	Outside Print
6	113.8" W x 166" H	Outside Print Backside
7	152.8" W x 80.32" H	Outside Print
8	152.8" W x 80.32" H	Inside Print
9	230.7" W x 35.8" H	Outside Print
10	230.7" W x 35.8" H	Inside Print
11	230.7" W x 35.8" H	Inside Print
12	35.8" W x 48.2" H	Outside Print
13	35.8" W x 86.8" H	Outside Print
14	35.8" W x 127" H	Outside Print
15	35.8" W x 127" H	Outside Print
16	35.8" W x 127" H	Outside Print
17	35.8" W x 166" H	Outside Print

Frame Assembly

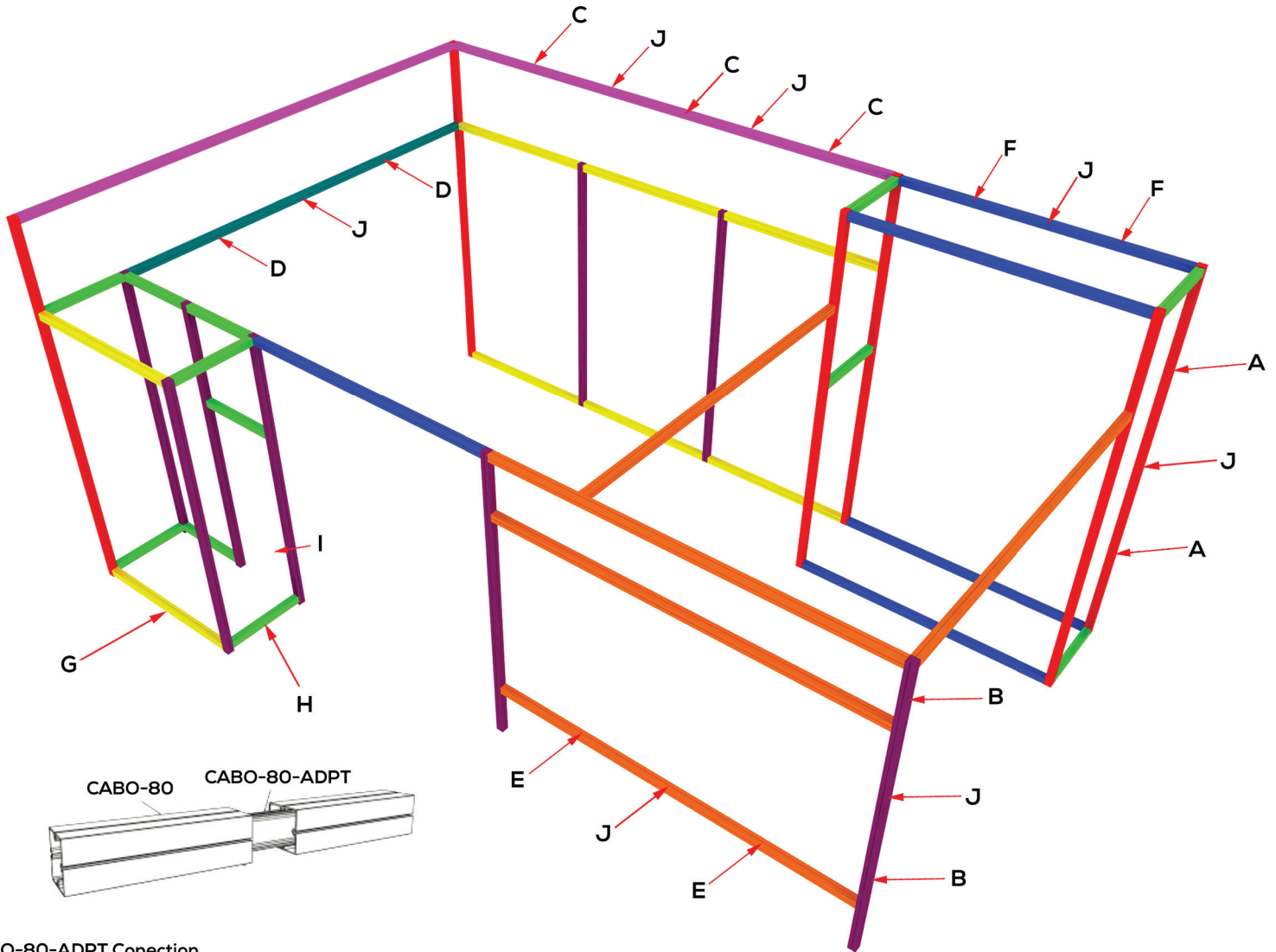

CABO-80-ADPT Connection

1. Insert CABO-80-ADPT into one CABO-80 profile
2. Slide opposing CABO-80 profile onto CABO-80-ADPT
3. Tighten screws on CABO-80-ADPT to secure profiles in place

REF	SKU	QTY	LENGTH IN
A	CABO-80	12	86.1"
B	CABO-80	16	66.65"
C	CABO-80	6	76.9"
D	CABO-80	2	95.85"
E	CABO-80	10	76.4"
F	CABO-80	10	56.9"
G	CABO-80	8	74.8"
H	CABO-80	12	35.8"
I	CABO-DOOR	2	n/a
J	CABO-80-ADPT	28	n/a

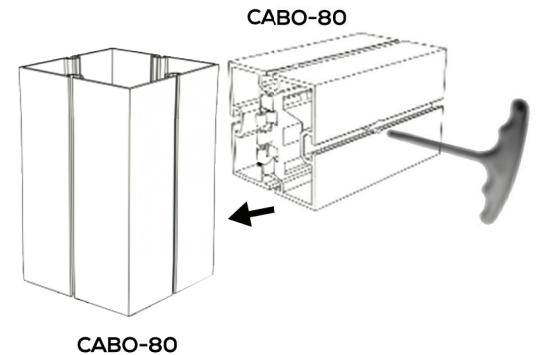

CABO 80 Profile Connection

1. Line up lock with system groove on vertical profile
2. Insert teeth of lock into groove
3. Use torx tool to tighten lock (turn clockwise to tighten)

SEG Attachments

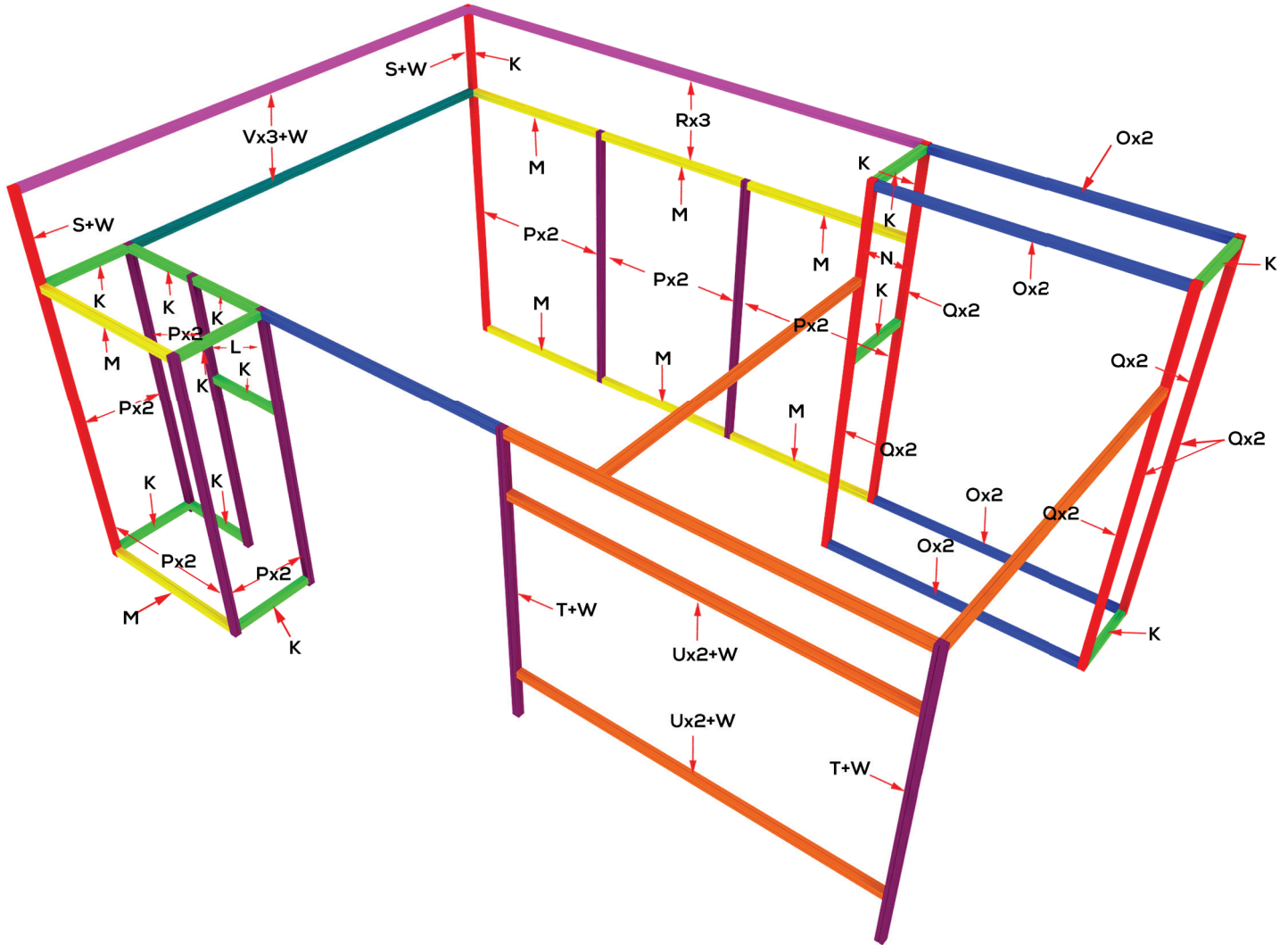

REF	SKU	QTY	LENGTH IN
K	CABO-SEG-PLASTIC	14	35.7"
L	CABO-SEG-PLASTIC	2	48.1"
M	CABO-SEG-PLASTIC	8	74.7"
N	CABO-SEG-PLASTIC	2	87.1"
O	CABO-SEG-PLASTIC	8	56.85"
P	CABO-SEG-PLASTIC	28	63.45"
Q	CABO-SEG-PLASTIC	12	82.95"
R	CABO-SEG-PLASTIC	6	76.9"
S	CABO-80-SEG	2	35.7"
T	CABO-80-SEG	2	70.8"
U	CABO-80-SEG	4	76.35"
V	CABO-80-SEG	6	76.9"
W	CABO-HHS	61	n/a

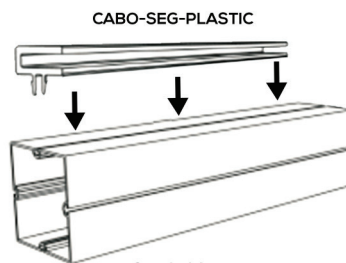

CABO-SEG-PLASTIC Installation
 1. Line up clip of CABO-SEG-PLASTIC with system groove of profile
 2. Press CABO-SEG-PLASTIC down to lock into place.

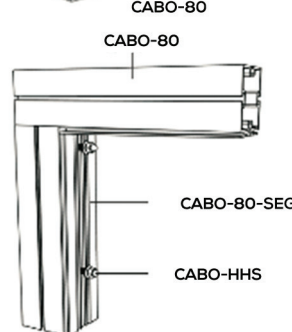

CABO-80-SEG Installation
 1. Unscrew CABO-HHS and feed through holes on CABO-80-SEG
 2. Line up CABO-HHS with system groove on profile CABO-80-SEG will attach to
 3. Tighten CABO-HHS clockwise to secure